

# GYNECOLOGY/OBSTETRICS INSTRUMENTS



OBSTETRICS &  
**GYNAECOLOGY**



**Dilatation and Curettage**

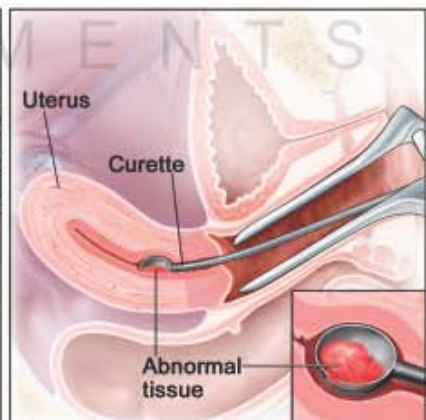
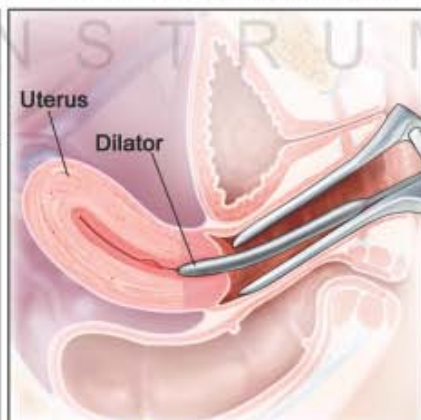
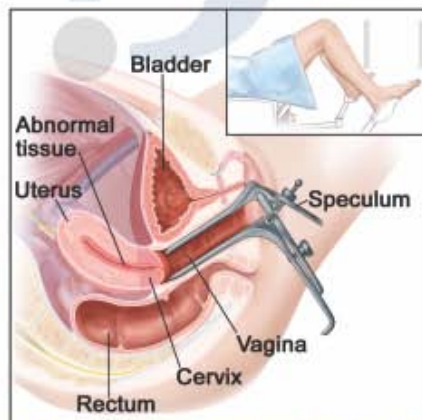



**Cusco vaginal speculum**  
17-001 75 mm x 32 mm  
17-002 85 mm x 35 mm  
17-003 100 mm x 35 mm  
17-004 75 mm x 17 mm  
for vierges



**Cusco vaginal speculum**  
17-005 75 mm x 32 mm  
17-006 80 mm x 35 mm  
17-007 100 mm x 37 mm



**Cusco vaginal speculum**  
17-008 80 mm x 22 mm  
17-009 100 mm x 25 mm  
17-010 105 mm x 27 mm  
Swiss pattern



**Grave vaginal speculum**  
17-011 75 mm x 20 mm  
17-012 95 mm x 35 mm  
17-013 115 mm x 35 mm



**Pederson vaginal speculum**  
17-014 75 mm x 13 mm  
17-015 100 mm x 22 mm  
17-016 120 mm x 25 mm



**Winterton**  
17-017



**Trelat vaginal speculum**  
17-018 85 mm x 30 mm  
17-019 95 mm x 35 mm  
17-020 115 mm x 43 mm



**Vaginal Speculum Cusco**  
17-021 Extra Small  
17-022 Small  
17-023 Medium  
17-024 Medium Extra long  
17-025 Large



**Semm vaginal speculum**  
17-026 90 mm x 14 / 18 mm  
17-027 100 mm x 17 / 20 mm  
17-028 110 mm x 25 / 30 mm

Scheidenspekulum | Espéculo vaginal  
Spéculum vaginal | Speculum vaginale



**Collin vaginal speculum**  
17-029 85 mm x 30 mm  
17-030 100 mm x 35 mm  
17-031 110 mm x 40 mm



**COLLIN**  
17-032  
55 x 10 mm



**NOTT**  
17-033 90 mm 30 mm  
17-034 100 mm 30 mm



**DE VILBISS**  
17-035  
4 x 27 mm  
102 mm x 32 mm  
Medium



**SEYFFERT**  
17-036 100 x 24 mm  
17-037 110 x 32 mm  
23 cm, 9"



**CUSCO**  
17-038 75 x 32 mm  
17-039 85 x 35 mm  
17-040 100 x 35 mm



**CUSCO**  
17-041 75 x 17 mm



**CUSCO**  
17-042 90 x 22 mm  
17-043 100 x 25 mm  
17-044 105 x 27 mm



**GRAVES**  
Virgin Speculaums  
Color Coated, Straight  
17-045 20mm x 75mm, Small  
17-046 35mm x 95mm, Medium  
17-047 35mm x 115mm, Large



**Graves Vaginal Speculum Leep / Lietz**  
17-048 Small  
17-049 Medium  
17-050 Large  
17-051 X-large



**Pederson Vaginal Speculum Leep / Lietz**  
17-052 Small  
17-053 Medium  
17-054 Large  
17-055 X-Large



**PEDERSON**  
Virgin Speculaums  
Color Coated  
17-056 17mm x 100mm, Narrow  
17-057 13mm x 75mm, Small  
17-058 22mm x 100mm, Medium  
17-059 25mm x 120mm, Large



**NEW PORT**  
**17-060**  
25 cm



**Lateral Vaginal Retractor**  
**17-061**  
21 cm



**Lateral Vaginal Retractor**  
**Blue Coated Leep / Lietz**  
**17-062** 21 cm

**BUSHIDO**  
INSTRUMENTS



**Side Wall Retractors**  
**17-063** 4-Sided Pederson Speculum, Medium  
**17-064** 4-Sided Pederson Speculum, Large  
Redundant Wall Retractor, 3.5 in. x .75 in. blades  
LateralWall Retractor, Closed Shanks, 2.25 in. blades  
LateralWall Retractor, Open Shanks, 2.5 in. blades



**Lateral Vaginal Retractor**  
**Blue Coated**  
**17-065** 26cm



**McGee Lateral Vaginal Retractor**  
**With Ratchet Handle**  
**17-066** 20cm

Scheidenspekulum | Espéculo vaginal  
Spéculum vaginal | Speculum vaginale



**Kogan Speculum  
17-067**  
24 cm  
with scale-ratchet  
and fixation screw



**Kogan Speculum  
17-068**  
24 cm



**Kogan - Modif.  
Speculum**  
28 cm  
**17-069**  
x=4 mm y=8mm  
**17-070**  
x=2 mm y=4mm



**Kogan Endocervical Spatula  
17-071**  
Ratchet, Standard Tips, 28cm  
Ratchet, Narrow Tips, 28cm  
Set Screw, Standard Tips, 28cm  
Set Screw, Narrow Tips, 28cm



**RAMATHIBODI  
17-072**  
27.5 cm  
Uterine Manipulator



**RAMATHIBODI  
17-073**  
25 cm  
Tubal hook



**Kristeller Speculum**  
**17-074** 70 mm x 27 mm  
**17-075** 80 mm x 30 mm  
**17-076** 90 mm x 36 mm  
**17-077** 110 mm x 27 mm  
**17-078** 110 mm x 30 mm  
**17-079** 110 mm x 36 mm



**Kristeller Retractor**  
**17-080** 75 mm x 23 mm  
**17-081** 85 mm x 26 mm  
**17-082** 100 mm x 32 mm  
**17-083** 115 mm x 23 mm  
**17-084** 115 mm x 26 mm  
**17-085** 115 mm x 32 mm



**Kristeller Speculum & Retractor**  
**17-086** 75 mm x 23 mm  
**17-087** 85 mm x 26 mm  
**17-088** 100 mm x 32 mm  
**17-089** 115 mm x 23 mm  
**17-090** 115 mm x 26 mm  
**17-091** 115 mm x 32 mm



**Kristeller Speculum**  
**17-092** 105 mm x 18 mm  
**17-093** 105 mm x 21 mm  
 Speculum tapered, for virgins



**Kristeller Retractor**  
**17-094** 110 mm x 14 mm  
**17-095** 115 mm x 17 mm



**Kristeller Speculum & Retractor**  
**17-096** 110 mm x 14 mm  
**17-097** 115 mm x 17 mm

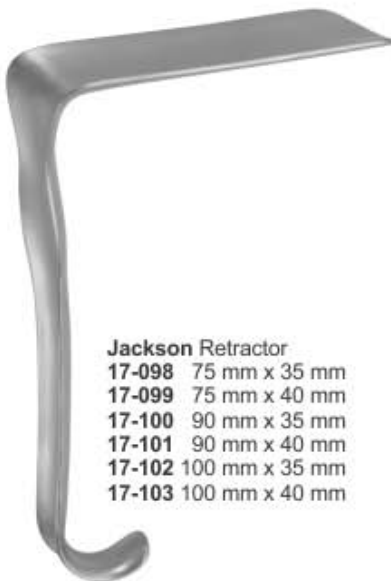

**Jackson Retractor**  
**17-098** 75 mm x 35 mm  
**17-099** 75 mm x 40 mm  
**17-100** 90 mm x 35 mm  
**17-101** 90 mm x 40 mm  
**17-102** 100 mm x 35 mm  
**17-103** 100 mm x 40 mm



**Sims Speculum & Retractor**  
**17-104** 70 mm x 25 mm / 30 mm  
**17-105** 75 mm x 30 mm / 35 mm  
**17-106** 80 mm x 35 mm / 40 mm

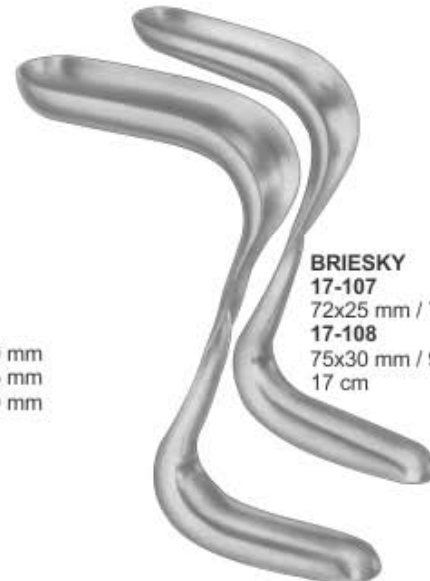

**BRIESKY**  
**17-107**  
 72x25 mm / 77x30 mm  
**17-108**  
 75x30 mm / 92x38 mm  
 17 cm

Vaginalspekulum und Retraktoren | Espéculo vaginal y retractores  
Spéculum et écarteurs vaginaux | Speculum vaginale e divaricatori



**Kallmorgen Speculum**  
17-109 70 mm x 40 mm  
17-110 90 mm x 40 mm



**Kallmorgen & Retractor**  
17-111 70 mm x 33 mm  
17-112 90 mm x 33 mm



**Kallmorgen Speculum & Retractor**  
17-113 70 mm x 33 mm  
17-114 90 mm x 33 mm



**MATHIEU Vaginal Speculum**  
17-115 Set 100x13mm-23mm  
17-116 95x16mm-26mm  
17-117 95x26mm-30 mm  
21 cm



**MATHIEU Vaginal Retractor**  
17-118 Set 100x17mm-30mm  
17-119 100x11mm-20mm  
17-120 100x14mm-26mm  
22 cm



**Doyen Vaginal Speculum**  
22 cm



Slightly Concave

17-121 60 x 35 mm  
17-122 90 x 35 mm  
17-123 120 x 35 mm  
17-124 60 x 45 mm  
17-125 90 x 45 mm  
17-126 120 x 45 mm  
17-127 160 x 45 mm  
17-128 60 x 60 mm  
17-129 90 x 60 mm  
17-130 120 x 60 mm  
17-131 160 x 60 mm

**Landon Vaginal Retractor**  
17-132  
Blade 9 cm  
Deep 2.5 cm wide.



56 x 13 mm

**BRAUN**  
17-133  
18 cm



60 x 10 mm

**BRAUN**  
17-134  
18 cm



**17-135**  
Handle with cold light carrier for upper blades  
28 cm

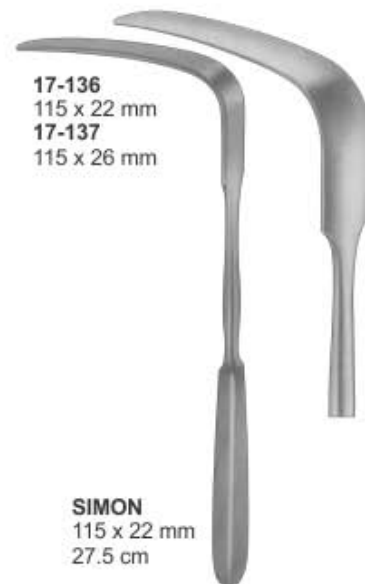

17-136 115 x 22 mm  
17-137 115 x 26 mm

**SIMON**  
115 x 22 mm  
27.5 cm

Vaginalspekulum und Retraktoren  
Spéculum et écarteurs vaginaux

Espéculo vaginal y retractores  
Speculum vaginale e divaricatori



95 x 17-26 mm

**MATHIEU**  
**17-138**  
For children and virgins fitting 21 cm



95 x 17 - 30 mm

**MATHIEU**  
**17-139**  
For children and virgins 21 cm



**LANDON**  
Vaginal Retractor  
**17-140**  
(2.5cm x 9cm x 20cm)  
Colour coated



**Wertheim**  
**Retractor**  
**17-141**  
(3cm x 9.5cm x 27.5cm)



**Landau**  
Speculum  
29 cm  
**17-142**  
100x 28 mm  
**17-143**  
100x 38 mm



**Breisky Speculum**  
30 cm  
**17-144**  
130x 20 mm  
**17-145**  
130 x 25 mm  
**17-146**  
130 x 30 mm  
**17-147**  
130 x 35 mm  
**17-148**  
130 x 40 mm  
Vienna pattern



**Breisky Speculum**  
30 cm  
**17-149**  
100 x 20 mm  
**17-150**  
100 x 25 mm  
**17-151**  
100 x 30 mm  
**17-152**  
100 x 35 mm  
**17-153**  
100 x 40 mm



**Breisky Speculum**  
35 cm  
**17-154**  
160 x 40 mm  
**17-155**  
180 x 40 mm



Veronikis Vaginal Retractors  
**17-156**  
(2.5 cm) blade width, 30cm length



Veronikis Vaginal Retractors  
**17-157**  
(2.5 cm) blade width, 34 cm length



Veronikis Vaginal Retractors  
**17-158**  
(3.8 cm) blade width, 30cm. length



Veronikis Vaginal Retractors  
**17-159**  
(2.5 cm) Tapered blade, 30cm. length



Scheidenspekulum | Espéculo vaginal  
Spéculum vaginal | Speculum vaginale



**Scherback Speculum  
17-160**  
Set consisting of:  
handle weight 5 blades

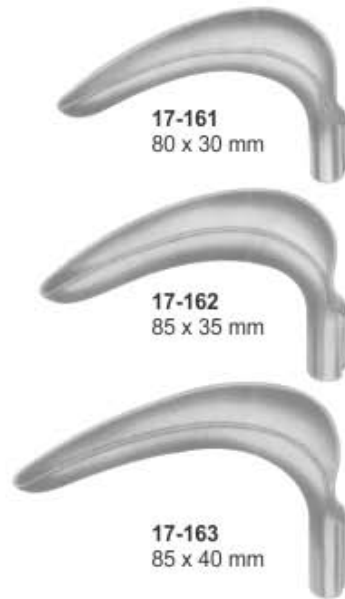

**17-161**  
80 x 30 mm

**17-162**  
85 x 35 mm

**17-163**  
85 x 40 mm



**17-164**  
55 x 40 - 60 mm

**17-165**  
70 x 45 - 70 mm



**Scherback Speculum  
17-166**  
Set consisting of:  
2 handle, 8 blades

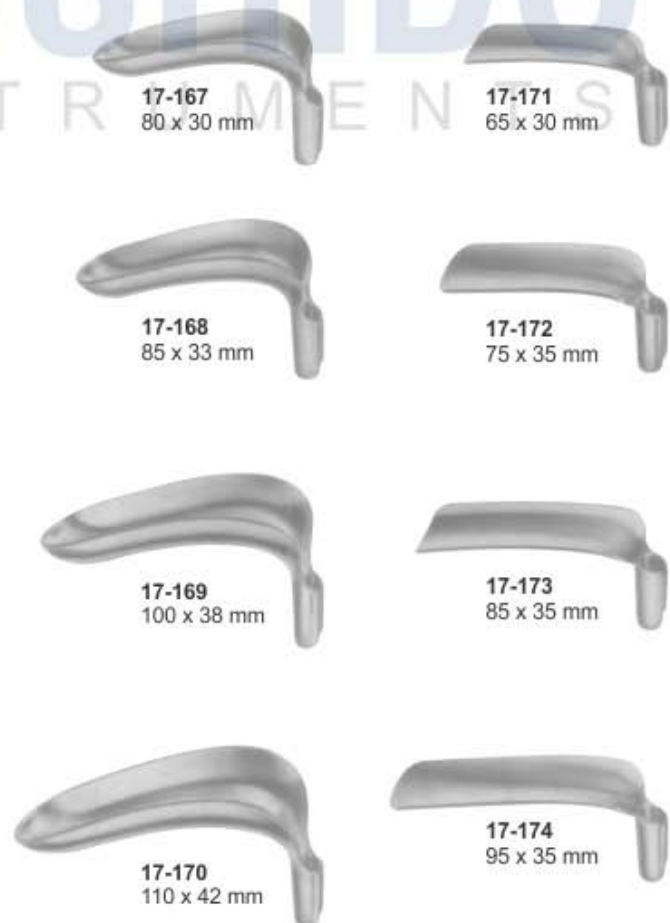

**17-167**  
80 x 30 mm

**17-171**  
65 x 30 mm

**17-168**  
85 x 33 mm

**17-172**  
75 x 35 mm

**17-169**  
100 x 38 mm

**17-173**  
85 x 35 mm

**17-170**  
110 x 42 mm

**17-174**  
95 x 35 mm

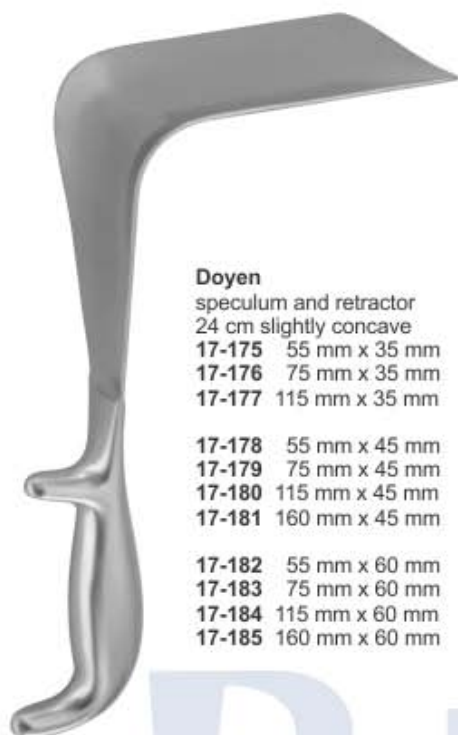

**Doyen**

speculum and retractor  
24 cm slightly concave

17-175 55 mm x 35 mm

17-176 75 mm x 35 mm

17-177 115 mm x 35 mm

17-178 55 mm x 45 mm

17-179 75 mm x 45 mm

17-180 115 mm x 45 mm

17-181 160 mm x 45 mm

17-182 55 mm x 60 mm

17-183 75 mm x 60 mm

17-184 115 mm x 60 mm

17-185 160 mm x 60 mm



**Doyen**

speculum and retractor  
24 cm medium concave

17-186 55 mm x 35 mm

17-187 75 mm x 35 mm

17-188 115 mm x 35 mm

17-189 55 mm x 45 mm

17-190 75 mm x 45 mm

17-191 115 mm x 45 mm

17-192 55 mm x 60 mm

17-193 75 mm x 60 mm

17-194 115 mm x 60 mm



17-195  
60 x 45 mm



17-196  
90 x 45 mm



17-197  
112 x 45 mm

**DOYEN**

Speculum & Retractor  
23.5 cm



**Garrigue Weighted Vaginal Speculum**  
17-198 4.0 cm x 8.0 cm  
Weight 2 lbs



**Henrotin Weighted Vaginal Speculum**  
17-199 3.8 cm x 9.0 cm  
Weight 3 lbs.



**AUVARD,**  
speculum & retractor  
17-200  
80 x 38 mm - 28 mm  
1,530 kg  
with fixed weight  
23 cm



**AUVARD**  
speculum & retractor  
17-201 75 x 42 mm  
17-202 80- x 43 mm  
(40 mm)  
17-203 105 x 43 mm  
(40 mm)  
with detachable weight  
23 cm



**WEISSBARTH**  
speculum & retractor  
17-204 80 x 28 mm  
17-205 85 x 42 mm  
21 cm

Scheidenspekulum | Espéculo vaginal  
Spéculum vaginal | Speculum vaginale



**AUVARD**  
**17-206**  
65 x 38 mm - 28 mm  
1,530 kg  
with fixed weight  
23 cm



**MARTIN**  
**17-207**  
with hook shaped  
handle for hanging  
in weights  
27 cm



**STEINER SPECULUM**  
Ideal for deep vaginal surgery.  
Blades may be ordered from  
4" to 7", 5.5" is normal length.

**17-208**  
1.1 Kg / 2.5 lb:  
14 cm x 3 cm



**HARDY-DUDDY SPECULUM**  
It will not fall out. Design places the 3.5 lbs  
weight at a right angle to the shaft of the  
speculum, preventing expulsion. Many  
blade options are available.

**17-209**  
**Hardy-Duddy Speculum,**  
3.5 lbs., 120 mm x 35 mm  
cupped blade



**AUVARD SPECULUM**  
An assortment of weighted  
Auvard specula is available.

**17-210**  
1.1 Kg / 2.5 lb:  
8.5 cm x 4 cm  
**17-211**  
1.1 Kg / 2.5 lb:  
10 cm x 4.5 cm



**NICHOLS WEIGHTED  
SPECULUM**  
Permits retraction of posterior  
vaginal wall, while providing  
suction and measurement of  
fluids from the surgical site.

**17-212**  
**Nichols Vaginal Weighted Speculum**  
with Suction, 2.5 lbs. 7cm x 3.8cm

Vaginal Retraktoren | Retractores vaginales  
Écarteurs vaginaux | Divaricatori vaginali



**O'Sullivan - O'Connor**  
Vaginal Retractor  
17-213 Set of 3 Complete



**17-214**  
45 x 17 mm



**17-215**  
90 x 45 mm



**17-216**  
90 x 37 mm



**Abdominal Retractor**  
17-217 9 cm wide  
17-218 10 cm wide  
17-219 11.5 cm wide

**BUSHIDO**  
INSTRUMENTS



**Friedmann Retractor**  
17-220  
10 cm



**COMYN BERKELEY**  
Vulva Self Retaining



**17-221**  
15.5cm



**DOYEN**  
Supra Hollow Handle  
17-222 7.5mm x 28cm  
17-223 9mm x 28cm  
17-224 10mm x 28cm  
17-225 11.5mm x 28cm



**DOYEN POZZI**  
Retractor  
17-226 4.5mm x 5mm x 25.5cm  
17-227 4.5mm x 9mm x 25.5cm  
17-228 4.5mm x 11.5mm x 25.5cm

Probeexzisionszangen

Pinzas saca-bocados para biopsia

Pinces emporte-pièces à biopsie

Pinze taglianti per biopsia



**Berger**  
Biopsy and Specimen Forceps  
17-229  
x = 200 mm

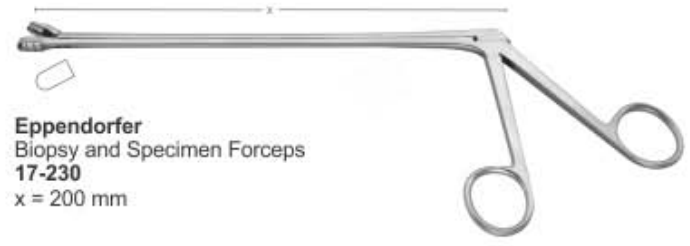

**Eppendorfer**  
Biopsy and Specimen Forceps  
17-230  
x = 200 mm

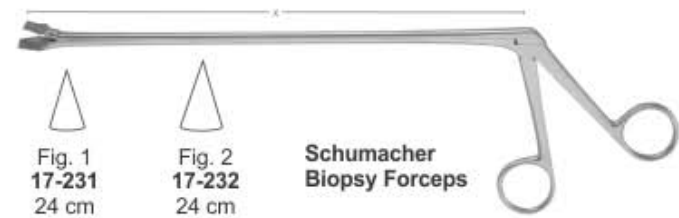

Fig. 1 17-231 24 cm  
Fig. 2 17-232 24 cm  
**Schumacher Biopsy Forceps**



**Kevorkian**  
Biopsy and Specimen Forceps  
17-233  
x = 245 mm



**Alexander**  
Biopsy and Specimen Forceps  
17-234 28 cm  
x = 200 mm

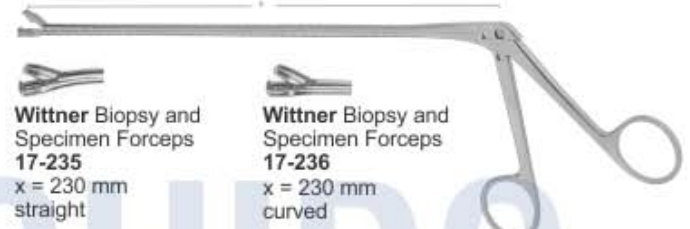

**Wittner Biopsy and Specimen Forceps**  
17-235  
x = 230 mm straight  
**Wittner Biopsy and Specimen Forceps**  
17-236  
x = 230 mm curved



**Schumacher**  
Biopsy and Specimen Forceps  
17-237 x = 23 cm complete  
17-238 x = 23 cm tip



**Tischler - Morgan**  
Biopsy and Specimen Forceps  
USA Modell  
17-239 x = 200 mm  
17-240 x = 250 mm  
**Tischler - Morgan**  
Biopsy and Specimen Forceps  
17-241 x = 200 mm  
17-242 x = 250 mm

Instruments as illustrated, but without locking screw.

USA Modell

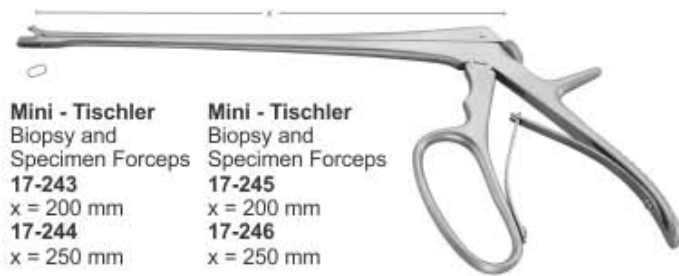

**Mini - Tischler**  
Biopsy and Specimen Forceps  
17-243 x = 200 mm  
17-244 x = 250 mm  
**Mini - Tischler**  
Biopsy and Specimen Forceps  
17-245 x = 200 mm  
17-246 x = 250 mm

Instruments as illustrated, but without locking screw.

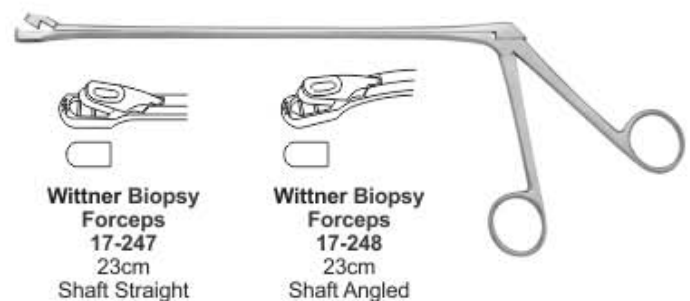

**Wittner Biopsy Forceps**  
17-247 23cm Shaft Straight  
**Wittner Biopsy Forceps**  
17-248 23cm Shaft Angled

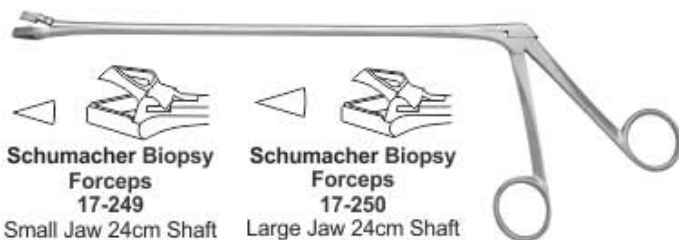

**Schumacher Biopsy Forceps**  
17-249 Small Jaw 24cm Shaft  
**Schumacher Biopsy Forceps**  
17-250 Large Jaw 24cm Shaft



**Tischler Baby Biopsy Forceps**  
17-251 21.5cm Shaft

Probeexzisionszangen

Pinzas saca-bocados para biopsia

Pinces emporte-pièces à biopsie

Pinze taglianti per biopsia



**Tischler Biopsy Forceps**  
17-252  
21.5cm Shaft



**Burke Biopsy Forceps**  
17-253  
21.5cm Shaft



**Eppendorf Biopsy Forceps**  
17-254  
20cm Shaft



**Kevorkian Young Biopsy Forceps**  
17-255  
25.5cm Shaft

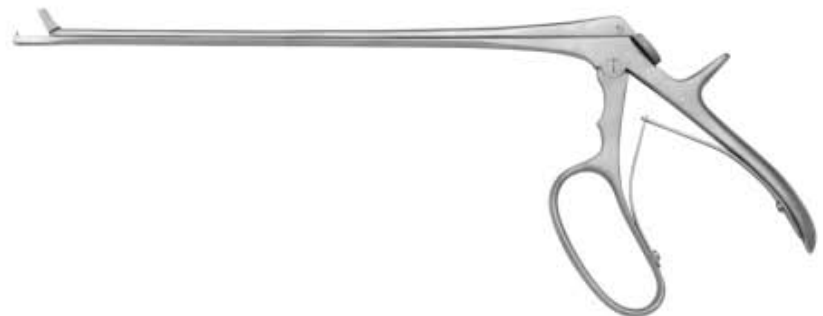

**Leechwilkinson Biopsy Forceps**  
17-256  
20cm Shaft Round



**BUSHIDO**  
INSTRUMENTS

Probeexzisionszangen

Pinzas saca-bocados para biopsia

Pinces emporte-pièces à biopsie

Pinze taglianti per biopsia



**Uni - Tischler**  
Biopsy and  
Specimen Forceps  
**17-258**  
3 x 7 mm  
Straight, Tip only



**Uni - Tischler**  
Biopsy and  
Specimen Forceps  
**17-259**  
3 x 7 mm  
up, Tip only



**Uni - Tischler**  
Biopsy and  
Specimen Forceps  
**17-260**  
3 x 7 mm  
down, Tip only

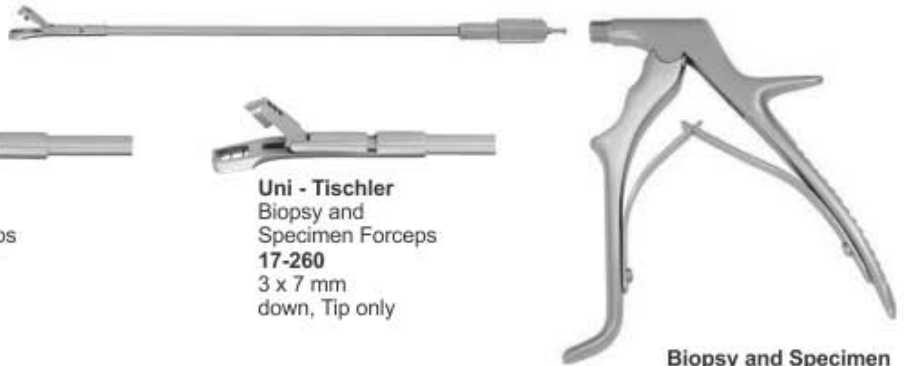

**Biopsy and Specimen  
Forceps Handle only  
17-257**



**Uni - Townsend**  
Biopsy and  
Specimen Forceps  
**17-261**  
2.3 x 4 mm  
straight, Tip only



**Uni - Townsend**  
Biopsy and  
Specimen Forceps  
**17-262**  
2.3 x 4 mm  
up, Tip only



**Uni - Townsend**  
Biopsy and  
Specimen Forceps  
**17-263**  
2.3 x 4 mm  
down, Tip only



**Uni - Kevorkian**  
Biopsy and  
Specimen Forceps  
**17-264**  
3 x 9 mm  
Tip only



**Uni - Oval**  
Biopsy and  
Specimen Forceps  
**17-265**  
3 x 5 mm  
Tip only



**Uni - Burke**  
Biopsy and  
Specimen Forceps  
**17-266**  
3 x 5 mm  
Tip only



**Uni - Tischler**  
Biopsy and  
Specimen Forceps  
**17-268**  
3 x 7 mm  
Straight, Tip only



**Uni - Tischler**  
Biopsy and  
Specimen Forceps  
**17-269**  
3 x 7 mm  
up, Tip only



**Uni - Tischler**  
Biopsy and  
Specimen Forceps  
**17-270**  
3 x 7 mm  
down, Tip only



**Biopsy and Specimen  
Forceps Handle only  
17-267**



**Uni - Townsend**  
Biopsy and  
Specimen Forceps  
**17-271**  
2.3 x 4 mm  
straight, Tip only



**Uni - Townsend**  
Biopsy and  
Specimen Forceps  
**17-272**  
2.3 x 4 mm  
up, Tip only



**Uni - Townsend**  
Biopsy and  
Specimen Forceps  
**17-273**  
2.3 x 4 mm  
down, Tip only

**Uni - Kevorkian**  
Biopsy and  
Specimen Forceps  
**17-274**  
3 x 9 mm  
Tip only



**Uni - Oval**  
Biopsy and  
Specimen Forceps  
**17-275**  
3 x 5 mm  
Tip only



**Uni - Burke**  
Biopsy and  
Specimen Forceps  
**17-276**  
3 x 5 mm  
Tip only

Polypenfasszange, Darm-anastomosenklemmen

Pince Pour Saisir Polypes, Pinces-clamps Pour Anastomose Intestinale

Pinza Para Coger Pólipos, Clamps Para Anastomosis Intestinales

Pinze Per Afferrare Polipi, Pinze Per Anastomosi Intestinali

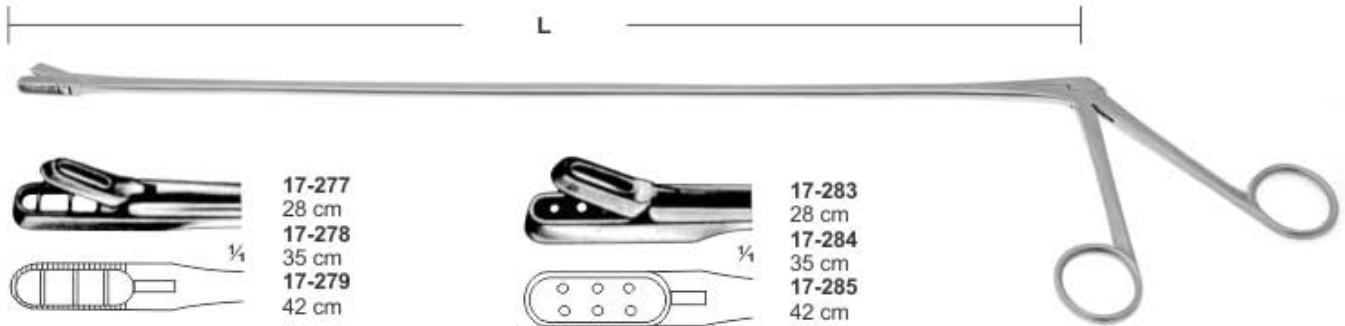

**17-277**  
28 cm  
**17-278**  
35 cm  
**17-279**  
42 cm

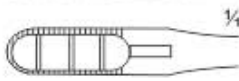

**17-283**  
28 cm  
**17-284**  
35 cm  
**17-285**  
42 cm



**17-280**  
28 cm  
**17-281**  
35 cm  
**17-282**  
42 cm



**17-286**  
28 cm  
**17-287**  
35 cm  
**17-288**  
42 cm

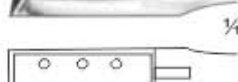

YEOMANN

PILE FORCEPS

COTTON CARRIER



**LURE**  
**17-289**  
24.5cm



**JARVIS**  
**17-290**  
23cm



**LANGENBECK**  
**17-291**  
45cm



**17-292**  
45cm



Probeexzisionszangen

Pinzas saca-bocados para biopsia

Pinces emporte-pièces à biopsie

Pinze taglienti per biopsia

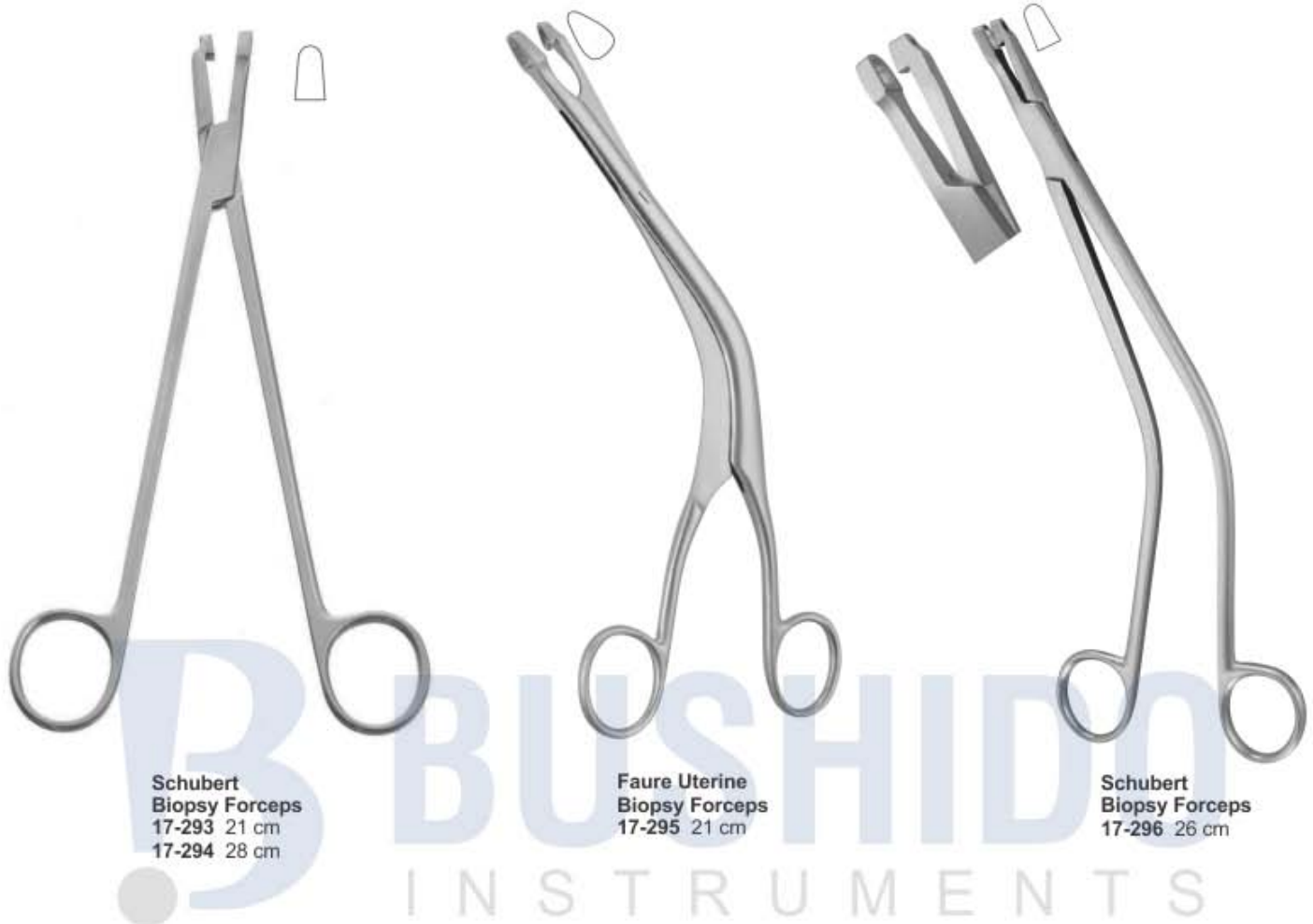

**Schubert  
Biopsy Forceps**  
17-293 21 cm  
17-294 28 cm

**Faure Uterine  
Biopsy Forceps**  
17-295 21 cm

**Schubert  
Biopsy Forceps**  
17-296 26 cm

BUSHIDO  
INSTRUMENTS



**Gellhorn  
Biopsy Forceps**  
17-297 23 cm

**Thoms-Gaylor  
Biopsy Forceps**  
17-298 22 cm  
17-299 24 cm

**Van Doren  
Biopsy Forceps**  
17-300 24 cm

**Schumacher  
Biopsy Forceps**

Fig. 1  
17-301  
24 cm

Fig. 2  
17-302  
24 cm

Hakenzangen

Pinzas para coger el cuello del útero

Pinces pour l'abaissement du col de l'utérus

Pinze per abbassare il collo dell'utero



Museux Tenaculum Forceps



24 cm  
**17-303**  
8 mm  
**17-304**  
6 mm  
**17-305**  
10 mm  
Straight

24 cm  
**17-306**  
8 mm  
**17-307**  
6 mm  
**17-308**  
10 mm  
Curved



Jacobs Uterine Vulsellum Forceps

**17-309**  
21 cm



**17-310**  
21 cm



**WINTER**  
**17-311** Fig. 1  
**17-312** Fig. 2  
**17-313** Fig. 3  
28 cm



Teale Tenaculum Forceps  
**17-314** 23 cm



Pratt  
Tenaculum Forceps  
**17-315** 26 cm



Czerny  
Tenaculum Forceps  
**17-316** 20.5 cm



Schroeder Vulsellum  
Tenaculum Forceps



**17-317** 24 cm  
**17-318** 24 cm

*Hakenzangen*

*Pinzas para coger el cuello del útero*

*Pinces pour l'abaissement du col de l'utérus*

*Pinze per abbassare il collo dell'utero*



**Pozzi Tenaculum Forceps**  
17-319 25.5 cm

**Schroeder Tenaculum Forceps**  
17-320 25 cm

**Duplay Tenaculum Forceps**  
17-321 28 cm

**Iowa Tenaculum Forceps**  
17-322 26 cm

**Skene Tenaculum Forceps**  
17-323 24 cm

BUSHIDO  
INSTRUMENTS



**Beacham Amniotome**  
17-324  
26 cm

**Staude - Moore Tenaculum Forceps**  
17-325 17 cm

**Barrett Tenaculum Forceps**  
17-326 18 cm

**Braun Tenaculum Forceps Sharp**  
17-327 25 cm

**Schroeder-Braun Tenaculum Forceps**  
17-328 25 cm  
sharp

17-329  
blunt

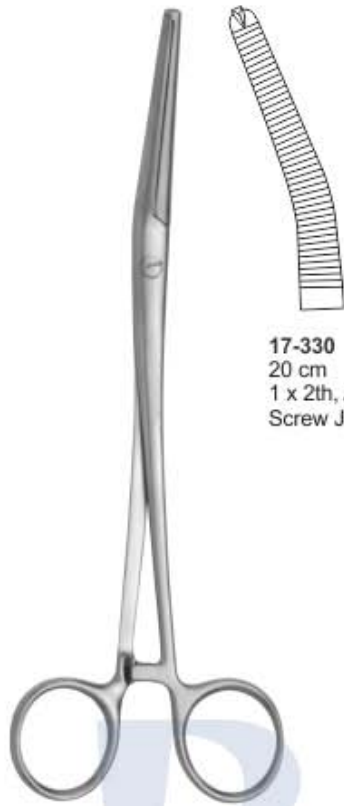

**17-330**  
20 cm  
1 x 2th, Angled  
Screw Joint

**BONNEY**

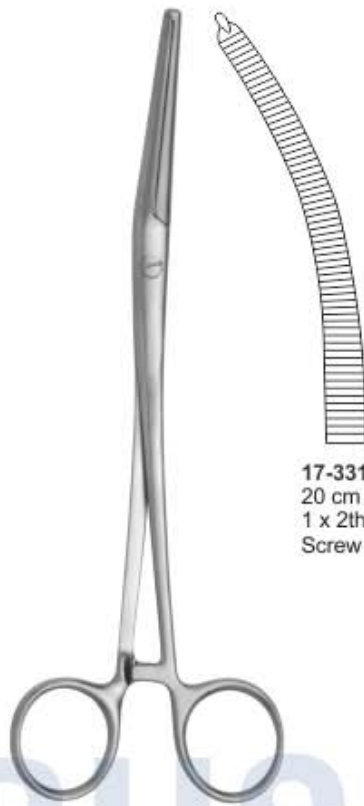

**17-331**  
20 cm  
1 x 2th, Curved  
Screw Joint

**BONNEY-BERKLEY**

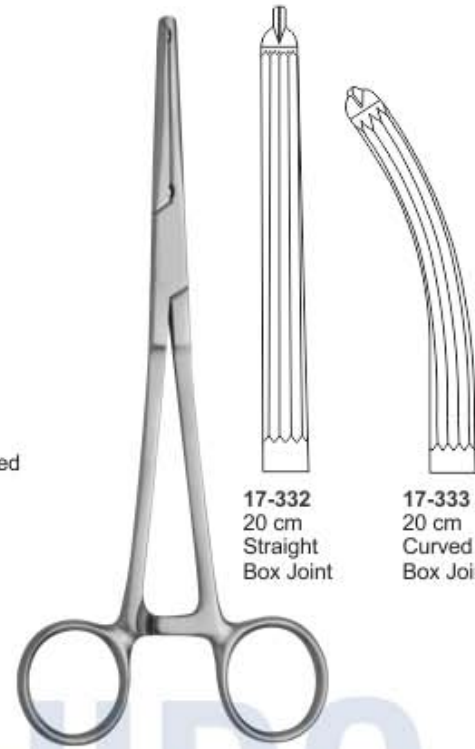

**17-332**  
20 cm  
Straight  
Box Joint

**17-333**  
20 cm  
Curved  
Box Joint

**GWILLIAM**

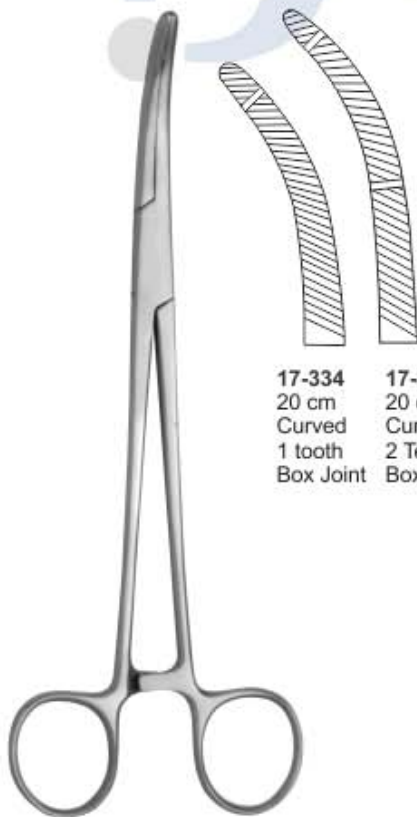

**17-334**  
20 cm  
Curved  
1 tooth  
Box Joint

**17-335**  
20 cm  
Curved  
2 Teeth  
Box Joint

**HEANEY**

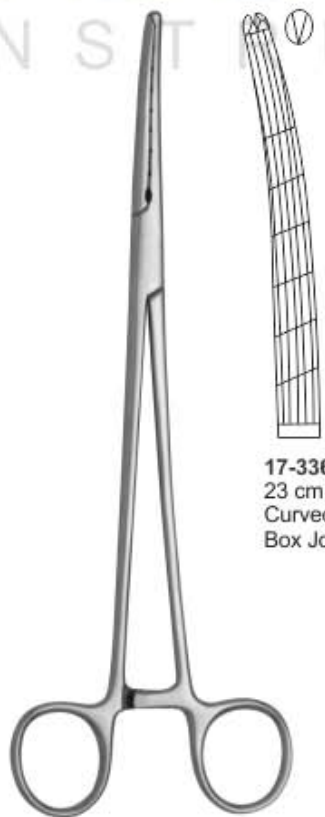

**17-336**  
23 cm  
Curved  
Box Joint

**HUNTER**

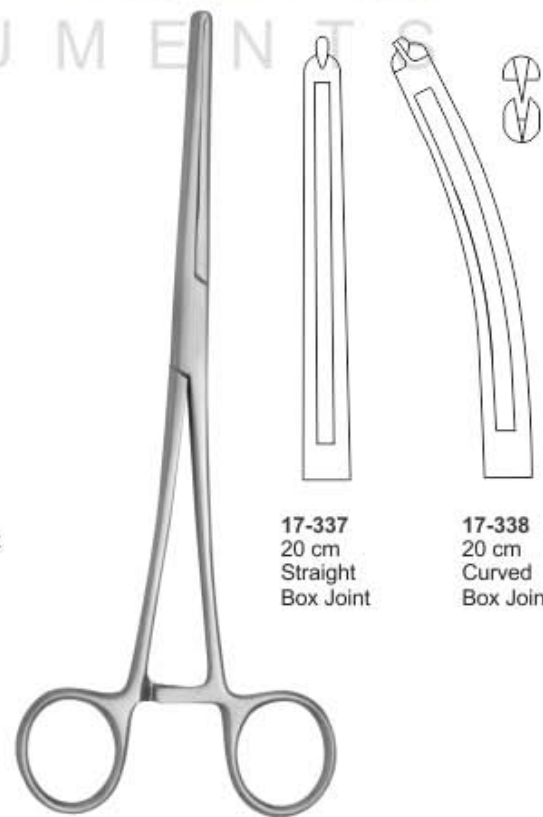

**17-337**  
20 cm  
Straight  
Box Joint

**17-338**  
20 cm  
Curved  
Box Joint

**MAINGOT**

# PARAMETRIUM FORCEPS, HYSTERECTOMY FORCEPS

Parametriumklemmen, Hysterektomieklemmen | Pinzas parametrium, Pinzas-clamps para histerectomia

Pinces parametrium, Pinces à hystérectomie | Pinze parametrium, Pinze per isterectomia



**Parametrium  
Hysterectomy  
Forceps**



**17-339**  
21 cm  
**17-340**  
24 cm  
**17-341**  
30 cm  
**17-342**  
35 cm

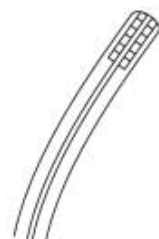

**17-343**  
21 cm  
**17-344**  
24 cm  
**17-345**  
30 cm  
**17-346**  
35 cm



**17-347**  
21 cm  
**17-348**  
24 cm  
**17-349**  
30 cm  
**17-350**  
35 cm

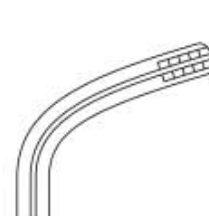

**17-351**  
21 cm  
**17-352**  
24 cm  
**17-353**  
30 cm  
**17-354**  
35 cm

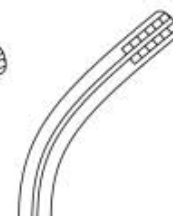

**17-355**  
21 cm  
**17-356**  
24 cm  
**17-357**  
30 cm  
**17-358**  
35 cm  
S-curved



**Rogers Parametrium  
Hysterectomy Forceps**

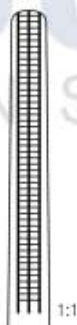

**17-359**  
Fig. 1  
22 cm



**17-360**  
Fig. 2  
21.5 cm



**17-361**  
Fig. 3  
21 cm

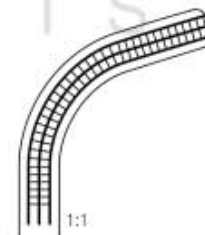

**17-362**  
Fig. 4  
20.5 cm

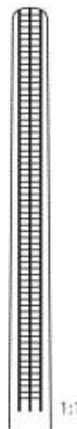

**17-363**  
Fig. 1  
25 cm

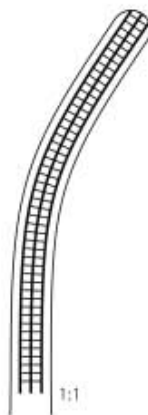

**17-364**  
Fig. 2  
25 cm

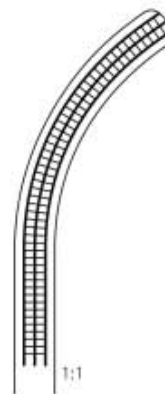

**17-365**  
Fig. 3  
24.5 cm

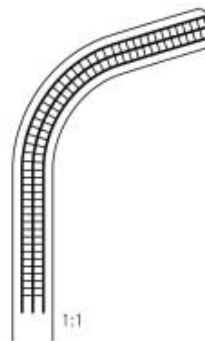

**17-366**  
Fig. 4  
23 cm



**Hank Uterine Dilators 6 Set**  
17-367 Complete Set  
Curved, Delicate, 11-12 Fr. to 21-22 Fr.  
(3.66mm to 7.33cm)

**Hank Uterine Dilators, Double-ended**  
17-368 11-12 Fr. (3.6mm x 4.0mm), 27.5cm  
17-369 13-14 Fr. (4.3mm x 4.7mm), 27.5cm  
17-370 15-16 Fr. (5.0mm x 5.3mm), 27.5cm  
17-371 17-18 Fr. (5.7mm x 6.0mm), 27.5cm  
17-372 19-20 Fr. (6.3mm x 6.7mm), 27.5cm  
17-373 21-22 Fr. (7.0mm x 7.3mm), 27.5cm

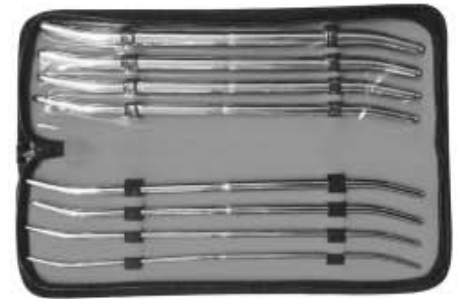

**Pratt Uterine Dilators 8/Set**  
17-374 Complete Set  
Curved, Delicate, 13-15 Fr. to 41-43 Fr., Straight

**Pratt Uterine Dilators, Double-ended**  
17-375 13 / 15 Fr., 29.5cm  
17-376 17 / 19 Fr., 29.5cm  
17-377 21 / 23 Fr., 29.5cm  
17-378 25 / 27 Fr., 29.5cm  
17-379 29 / 31 Fr., 29.5cm  
17-380 33 / 35 Fr., 29.5cm  
17-381 37 / 39 Fr., 29.5cm  
17-382 41 / 43 Fr., 29.5cm



**Hegar uterine dilator**  
17-383 3 / 4 mm - 17 / 18 mm Ø  
8 Pieces per set  
17-384 1 / 2 mm - 25 / 26 mm Ø  
13 Pieces per set

**Hegar uterine dilator**  
17-385 1 / 2 mm Ø  
17-386 3 / 4 mm Ø  
17-387 5 / 6 mm Ø  
17-388 7 / 8 mm Ø  
17-389 9 / 10 mm Ø  
17-390 11 / 12 mm Ø  
17-391 13 / 14 mm Ø  
17-392 15 / 16 mm Ø  
17-393 17 / 18 mm Ø  
17-394 19 / 20 mm Ø  
17-395 21 / 22 mm Ø  
17-396 23 / 24 mm Ø  
17-397 25 / 26 mm Ø  
double ended



**Hegar Uterine Dilators 8 Set W/Roll**  
17-398 Complete Set  
Curved, Delicate, 3mm to 18mm, Curved

**Hegar Uterine Dilator, Double-ended**  
17-399 3mm & 4mm, (20cm)  
17-400 5mm & 6mm, (20cm)  
17-401 7mm & 8mm, (20cm)  
17-402 9mm & 10mm, (20cm)  
17-403 11mm & 12mm, (20cm)  
17-404 13mm & 14mm, (20cm)  
17-405 15mm & 16mm, (20cm)  
17-406 17mm & 18mm, (20cm)

Uterusdilatoren | Dilataores uterinos  
 Dilataeurs utérins | Dilatori uterini

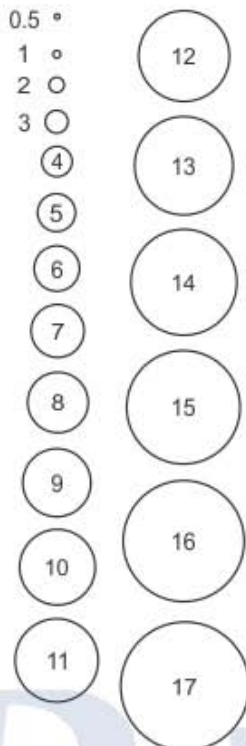

- 17-408 18.5cm 3-4-5mm
- 17-409 18.5cm 4-5-6mm
- 17-410 18.5cm 5-6-7mm
- 17-411 18.5cm 6-7-8mm
- 17-412 18.5cm 7-8-9mm
- 17-413 18.5cm 8-9-10mm
- 17-414 18.5cm 9-10-11mm
- 17-415 18.5cm 10-11-12mm
- 17-416 18.5cm 11-12-13mm
- 17-417 18.5cm 12-13-14mm
- 17-418 18.5cm 13-14-15mm
- 17-419 18.5cm 14-15-16mm
- 17-420 18.5cm 15-16-17mm
- 17-421 18.5cm 16-17-18mm
- 17-422 18.5cm 17-18-19mm
- 17-423 18.5cm 18-19-20mm

Canvas Roll

**Bonney-Barker Dilators**  
 17-407 Set of 16 Pcs



**Hank Double Ended**  
 17-424 Set of 6 Pcs



- 17-425 27cm 9/10mm
- 17-426 27cm 11/12mm
- 17-427 27cm 13/14mm
- 17-428 27cm 15/16mm
- 17-429 27cm 17/18mm
- 17-430 27cm 19/20mm

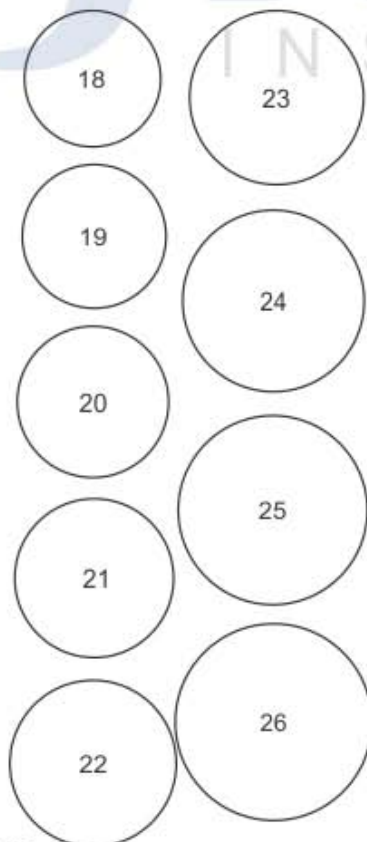

- 17-432 17cm 3-6mm
- 17-433 17cm 4-7mm
- 17-434 17cm 5-8mm
- 17-435 17cm 6-9mm
- 17-436 17cm 7-10mm
- 17-437 17cm 8-11mm
- 17-438 17cm 9-12mm
- 17-439 17cm 10-13mm
- 17-440 17cm 11-14mm
- 17-441 17cm 12-15mm
- 17-442 17cm 13-16mm
- 17-443 17cm 14-17mm
- 17-444 17cm 15-18mm
- 17-445 17cm 16-19mm
- 17-446 17cm 17-20mm
- 17-447 17cm 18-21mm

Canvas Roll Only

**Hawkin Ambler Dilators**  
 17-431  
 Set of 16 Pcs



**Hegar Double Ended Dilators**



- 20cm 1/2mm
- 20cm 3/4mm
- 20cm 5/6mm
- 20cm 7/8mm
- 20cm 9/10mm
- 20cm 11/12mm
- 20cm 13/14mm
- 20cm 15/16mm
- 20cm 17/18mm
- 20cm 19/20mm
- 20cm 21/22mm
- 20cm 23/24mm
- 20cm 25/26mm
- 17-448 Set 8 Double Ended 3/4mm-17/18mm
- 17-449 Set 12 Double Ended 1/2mm-23/24mm
- 17-450 Set 8 Double Ended Canvas Only
- 17-451 Set 12 Double Ended Canvas Only



17-454	1mm Ø	17-484	1.5mm Ø
17-455	2mm Ø	17-485	2.5mm Ø
17-456	3mm Ø	17-486	3.5mm Ø
17-457	4mm Ø	17-487	4.5mm Ø
17-458	5mm Ø	17-488	5.5mm Ø
17-459	6mm Ø	17-489	6.5mm Ø
17-460	7mm Ø	17-490	7.5mm Ø
17-461	8mm Ø	17-491	8.5mm Ø
17-462	9mm Ø	17-492	9.5mm Ø
17-463	10mm Ø	17-493	10.5mm Ø
17-464	11mm Ø	17-494	11.5mm Ø
17-465	12mm Ø	17-495	12.5mm Ø
17-466	13mm Ø	17-496	13.5mm Ø
17-467	14mm Ø	17-497	14.5mm Ø
17-468	15mm Ø	17-498	15.5mm Ø
17-469	16mm Ø	17-499	16.5mm Ø
17-470	17mm Ø	17-500	17.5mm Ø
17-471	18mm Ø	17-501	18.5mm Ø
17-472	19mm Ø	17-502	19.5mm Ø
17-473	20mm Ø	17-503	20.5mm Ø
17-474	21mm Ø	17-504	21.5mm Ø
17-475	22mm Ø	17-505	22.5mm Ø
17-476	23mm Ø	17-506	23.5mm Ø
17-477	24mm Ø		
17-478	25mm Ø		
17-479	26mm Ø		
17-480	27mm Ø		
17-481	28mm Ø		
17-482	29mm Ø		
17-483	30mm Ø		

Hegar with siped handle	Set	mm	pieces per set
	17-452	4-17	14
	17-453	1-26	26



**Hegar Uterine Dilator**

single ended  
17-507 4 mm - 17 mm Ø  
8 Pieces per set  
17-508 1 mm - 26 mm Ø  
24 Pieces per set



**Hegar Uterine Dilator**

single ended  
17-509 4 mm - 17 mm Ø  
24 pieces per set



Retraktoren und Salpingograph | Retractores y Salpingografía  
Écarteurs et salpingographe | Divaricatori e salpingografi



**17-510**  
20cm

**GELPI**  
Vulva Self Retaining



**DOYEN**  
Vaginal Flat Retractor  
**17-511**  
1.75mm x 10mm x 23cm



**JOLL Thyroid Self Retaining**  
**17-512** 15.5cm



**Forceps for I.U.D Removing**  
**17-513**  
4 mm Ø x=230 mm



**17-514**  
IUP Grasping Forceps 3 mm  
22 cm



**Schulze, Salpingograph**  
**17-515** 29.5 cm  
complete in wooden case



Catheres Retraktoren & Verbandzangen

Retradores de catéteres y pinzas de apósito

Écarteurs et pinces à pansements Catheres

Divaricatori Catheres e pinze per medicazione



5mm  
17-516 5mm x 25mm  
11.5cm  
17-517 5mm x 50mm  
14cm  
17-518 5mm x 80mm  
17cm  
Cannula

**HORMONE**  
Implant Trocar Set

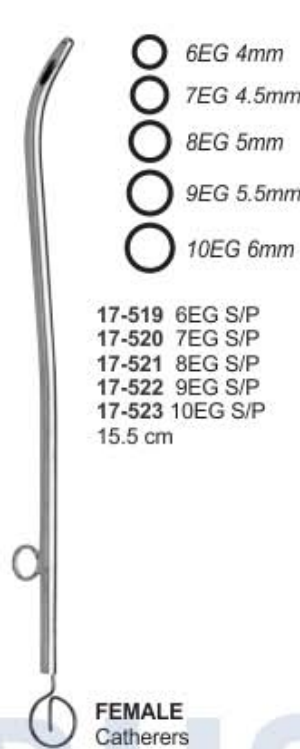

6EG 4mm  
7EG 4.5mm  
8EG 5mm  
9EG 5.5mm  
10EG 6mm  
17-519 6EG S/P  
17-520 7EG S/P  
17-521 8EG S/P  
17-522 9EG S/P  
17-523 10EG S/P  
15.5 cm

**FEMALE**  
Catherers



8EG 5mm  
10EG 6mm  
17-524 8EG S/P  
17-525 10EG S/P  
19cm

**ROTUNDA**  
Catherers



6EG 4mm  
8EG 5mm  
10EG 6mm  
12EG 7mm  
**FEMALE**  
Bladder Sounds  
17-526 6EG S/P  
17-527 8EG S/P  
17-528 10EG S/P  
17-529 12EG S/P  
24cm

**FEMALE**  
Bladder Sounds  
17-526 6EG S/P  
17-527 8EG S/P  
17-528 10EG S/P  
17-529 12EG S/P  
24cm

**NEEDLE EXTENSIONS**



**LEUR**  
Needle Extensions  
17-530 7.5cm  
17-531 10cm  
17-532 13cm

**LEUR**  
Needle Extensions  
17-530 7.5cm  
17-531 10cm  
17-532 13cm



**BOZEMAN**  
Dressing Forceps  
27cm  
Box Joint

**BOZEMAN**  
Dressing Forceps  
27cm  
Box Joint



17-533  
Serrated



17-534  
Grooved



17-535  
Large Bow  
Serrated



**BONNEY**  
Vaginal Clamps  
17-536  
34.5cm  
Screw Joint

**BONNEY**  
Vaginal Clamps  
17-536  
34.5cm  
Screw Joint



**VAGINAL**  
Dressing Forceps  
17-537  
24cm  
Serrated

**VAGINAL**  
Dressing Forceps  
17-537  
24cm  
Serrated

*Uterus-Sonden*

*Histerómetros uterinos*

*Hystéromètres du col de l'utérus*

*Isterometri uterini*

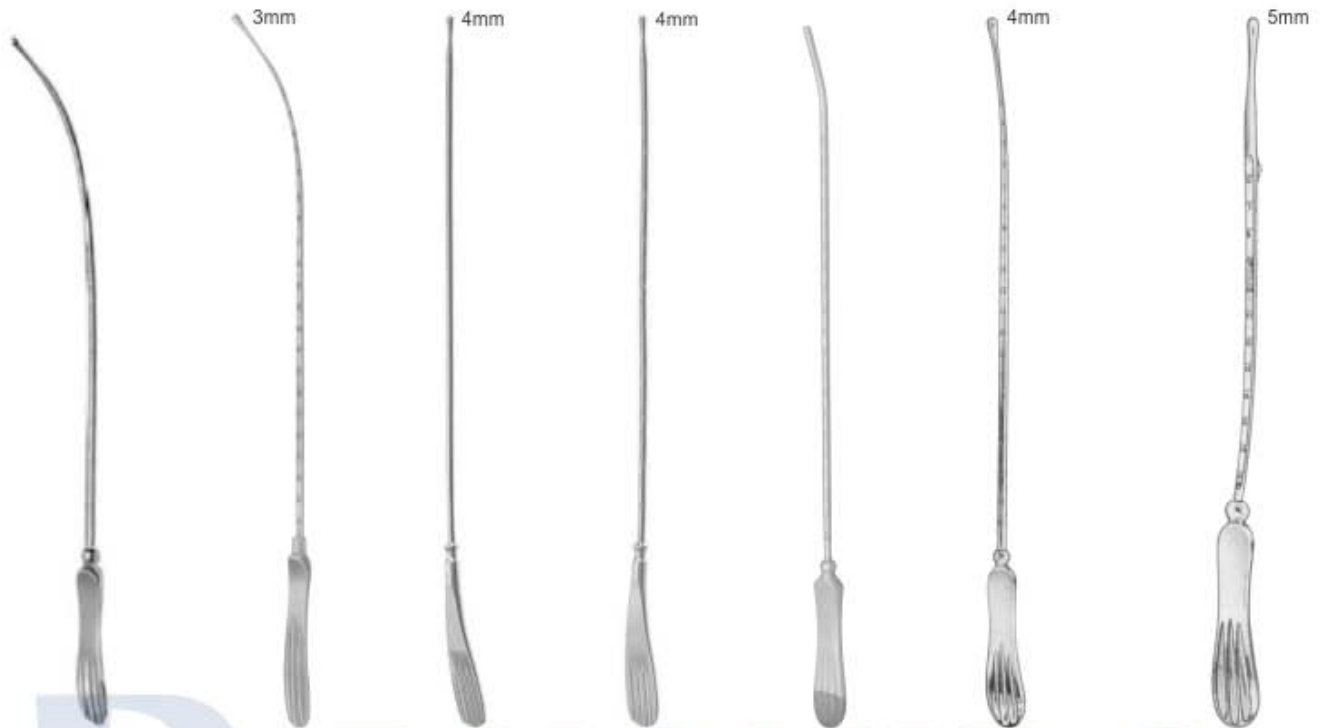

**Sims Uterine Sound**  
17-538 32 cm  
right, graduated in cm  
17-539 32 cm  
malleable graduated in cm

**Sims Uterine Sound**  
17-540  
33 cm  
right, malleable

**Sims Uterine Sound**  
17-541  
32.5cm  
Non-graduated

**Sims Uterine Sound**  
17-542  
32.5cm  
Graduated in cm

**Sims Uterine Sound**  
17-543  
24cm  
Graduated in cm

**Sims-Special Uterine Sound**  
17-544  
33 cm

**Sims Uterine Sound**  
schwed. Modell  
17-545  
26 cm



**Martin Uterine Sound**  
17-546 30 cm



**Valleix Uterine Sound**  
17-547 25 cm



**Mayo Uterine Sound**  
17-548 33 cm  
biegsam malleable



**Simpson Uterine Sound**  
17-549 29 cm  
malleable silver-plated



**Simpson Uterine Sound**  
17-550 32.5cm  
Graduated in inches



**SMELLIE**  
17-551  
30 cm



**Braun, Midwifery  
Decapitating hook**  
17-552  
32.5 cm



**Suture Retrieval  
Hook**  
17-553  
27cm



**Suture Retrieval  
Hook  
Sims Handle**  
17-554  
27 cm



**IRIS  
Skin Hooks**



17-556  
25.5cm  
Fine  
Colour  
Coated

**IRIS**  
Skin Hooks



**TENACULUM EMETT**



17-557  
23cm  
\*bic\*

**TENACULUM 3 PRONG**



**WHITTAKER**



17-558  
26cm  
\*bic\*



17-559  
18.5cm  
\*bic\*

BUSHIDO  
INSTRUMENTS

Myom-Instrumente, Fistelhaken

Instrumentos para fibroma, Ganchos para fistulas

Instruments pour myomes, Crochets pour fistules

Strumenti per miomi, Uncini per fistole



**Second Myoma Knife  
Fistula Hook**  
17-560  
27 cm

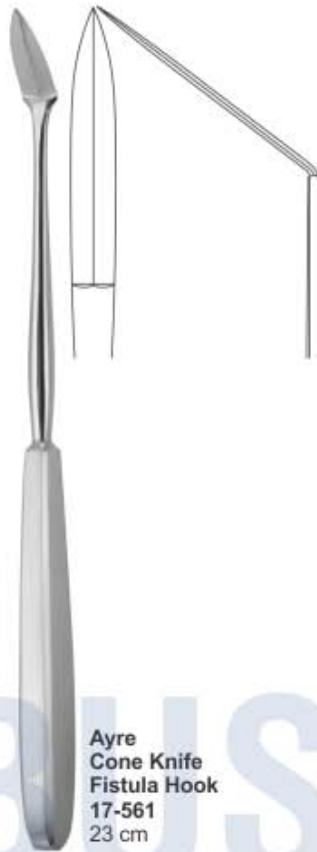

**Ayre Cone Knife  
Fistula Hook**  
17-561  
23 cm



**Doyen Myoma Screw  
And Fistula Hook**  
17-562 14.5cm  
17-563 17 cm



**Fig. 1**  
17-564  
22 cm



**Simon  
Fistula Hook,  
One Prong**



**Fig. 2**  
17-565  
22 cm



**Simon  
Fistula Hook,  
Two Prong**



**Fig. 1**  
17-566  
22 cm



**Fig. 3**  
17-568  
22 cm



**Emmet  
Fistula Hook**



**Fig. 2**  
17-567  
22 cm



**Fig. 4**  
17-569  
22 cm



**Fig. 5**  
17-570  
22 cm

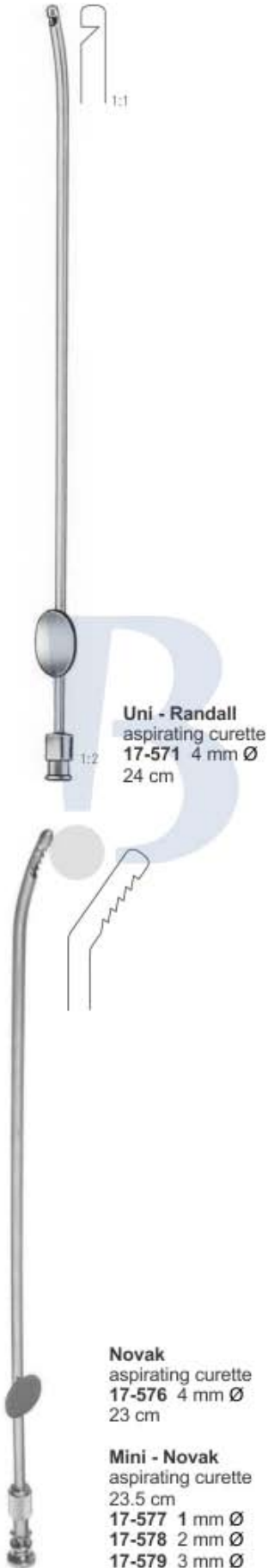

**Uni - Randall**  
aspirating curette  
**17-572**  
30 cm  
rigid, without basket

**Uni - Randall**  
aspirating curette  
**17-573**  
30 cm  
malleable,  
without basket



**Uni - Randall**  
aspirating curette  
**17-574**  
30 cm  
rigid, with basket

**Uni - Randall**  
aspirating curette  
**17-575**  
30 cm  
malleable,  
with basket

**Specimen And Aspirating Curette**  
20 cm

<b>17-580</b>	3 mm Ø
<b>17-581</b>	4 mm Ø
<b>17-582</b>	6 mm Ø
<b>17-583</b>	8 mm Ø
<b>17-584</b>	10 mm Ø
<b>17-585</b>	12 mm Ø
<b>17-586</b>	14 mm Ø

**Coupling Piece**  
aspirating curette  
12 cm  
**17-587**



Küretten spülen | Curetas de lavado  
Curettes de rinçage | Curette di lavaggio

**17-588**  
Small 29cm  
8mm Sharp

**17-591**  
Small 29cm  
8mm Blunt

**17-589**  
Medium 29cm  
11mm Sharp

**17-592**  
Medium 29cm  
11mm Blunt

**17-590**  
Large 29cm  
14mm Sharp

**17-593**  
Large 29cm  
14mm Blunt

**17-594**  
12 FG 4mm  
25.5cm

1mm 25.5cm  
2mm 25.5cm  
3mm 25.5cm  
4mm 25.5cm

2mm 25.5cm  
3mm 25.5cm  
4mm 25.5cm

1 ● 17-595  
2 ● 17-596  
3 ● 17-597  
4 ● 17-598

2 ● 17-599  
3 ● 17-600  
4 ● 17-601

**Rheinstadter Flushing Currettes**

**Rheinstadter Flushing Currettes**

**Leechwilkinson Suction Biopsy Currettes**

**Novak Suction Biopsy Currettes**

**Randall Suction Biopsy Currettes**

**17-602**  
10FG  
23cm C/P

10FG 3.3mm

**17-603**

**17-604**

**17-605**

**17-606**

**17-607**

**17-608**

**17-609**  
30 cm  
1.2mm

**17-610**  
30 cm  
4.0 mm  
Without Basket

**17-611**  
30 cm  
4.0 mm  
With Basket

**17-612**  
30.5cm

**Sharman Endometrial Biopsy Currettes**

**SCHROEDER**  
30 cm, 12" sharp, rigid

**KEVORKIAN**

**Kevorkian Endocervical Currettes**  
With Basket Round

Uteruslöffel, Absaugküretten, uterusdepressor

Curettes uterines, curettes d'aspiration, Dépresseur utérin

Cucharillas uterinas, Curetas aspiradoras, depresor uterino

Curette uterine, curette pe aspirazione, depressore uterino



17-613  
30.5cm

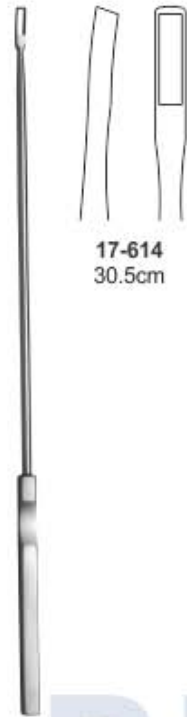

17-614  
30.5cm



Braun Uterine Depressor  
17-615 28 cm

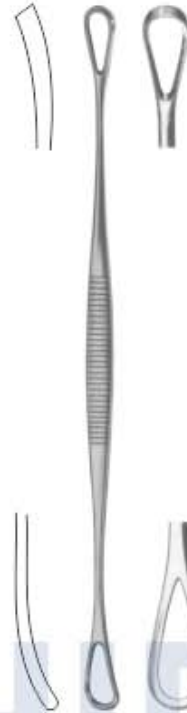

Blake Double Ended  
17-616 24.5 cm  
Sharp / Blunt

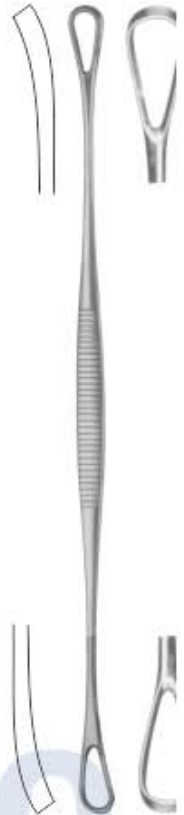

Zweifel Double Ended  
17-617 24.5cm  
Sharp / Sharp

Kevorkian  
Endocervical  
Curettes  
With Basket Square

Kevorkian  
Endocervical  
Curettes  
Without Basket Square



Coakley  
17cm



17-618  
Fig. 1



17-619  
Fig. 2



17-620  
Fig. 3



17-621  
Fig. 4



17-622  
Fig. 5



17-623  
Fig. 6



# UTERINE CURETTES

Uterusküretten | Currettes uterinas  
Currettes utérines | Curette uterine

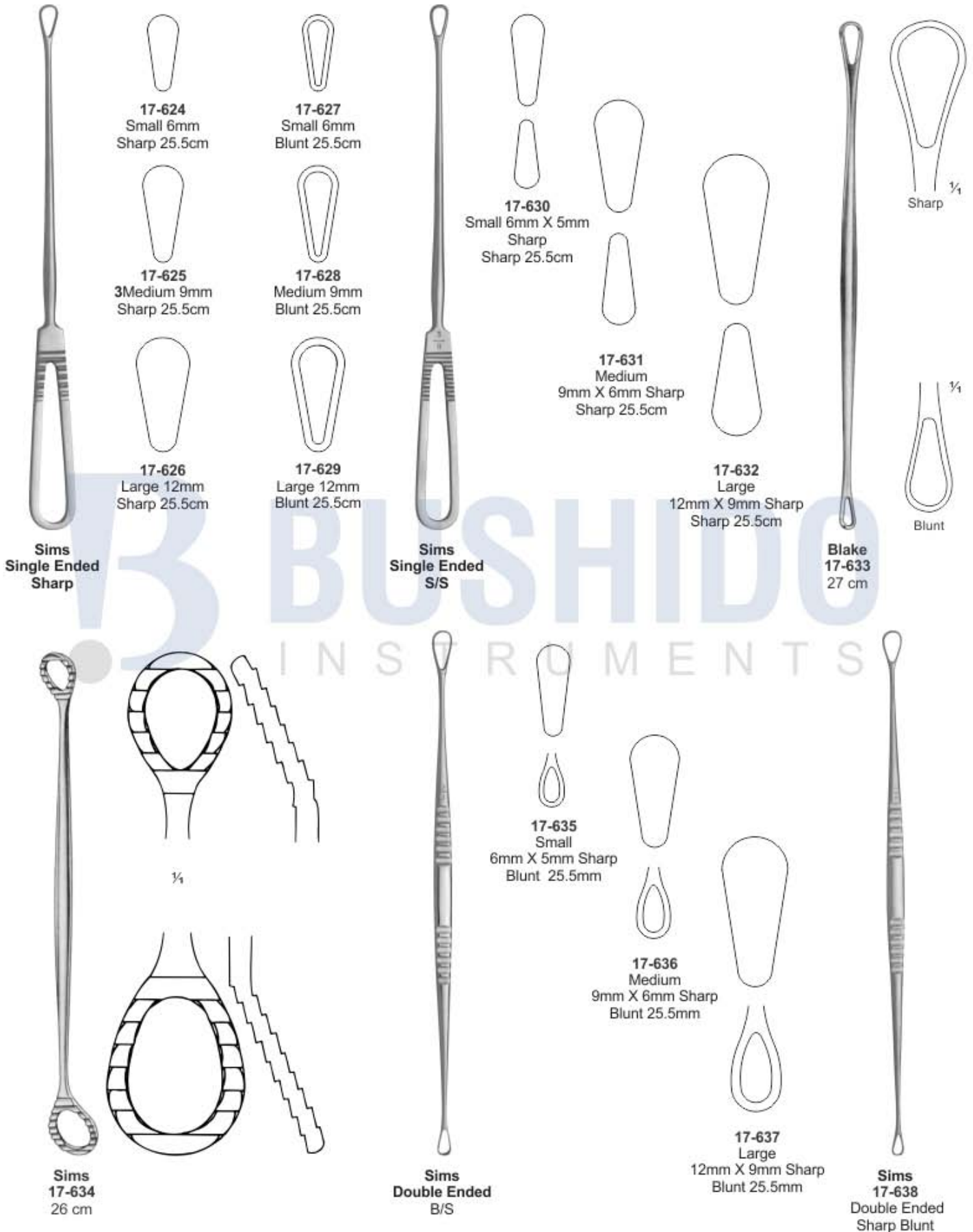

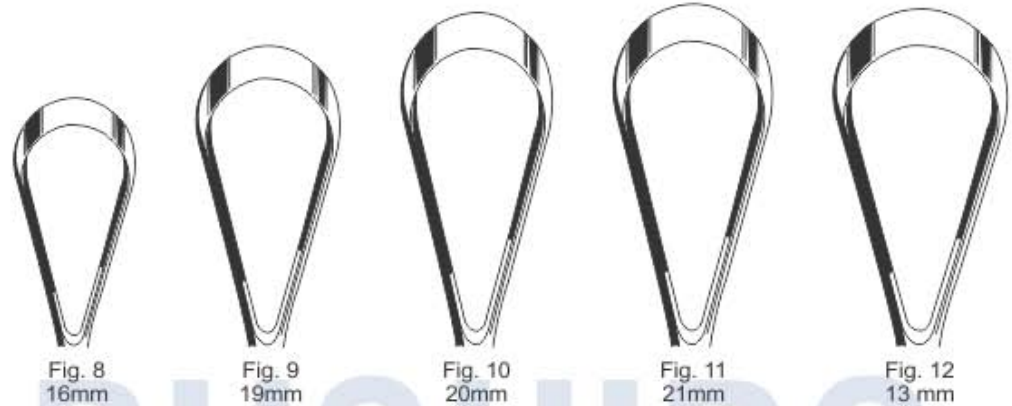

**Recamier**  
uterine curette  
y=26 cm

Fig.	x=mm	Sharp, malleable	Blunt, malleable	Sharp, rigid	Blunt, rigid
00	5	17-639	17-653	17-667	17-681
0	6	17-640	17-654	17-668	17-682
1	7	17-641	17-655	17-669	17-683
2	8	17-642	17-656	17-670	17-684
3	9	17-643	17-657	17-671	17-685
4	11	17-644	17-658	17-672	17-686
5	12	17-645	17-659	17-673	17-687
6	14	17-646	17-660	17-674	17-688
7	15	17-647	17-661	17-675	17-689
8	16	17-648	17-662	17-676	17-690
9	19	17-649	17-663	17-677	17-691
10	20	17-650	17-664	17-678	17-692
11	21	17-651	17-665	17-679	17-693
12	23	17-652	17-666	17-680	17-694

**Recamier**  
uterine curette  
y=31 cm

Fig.	x=mm	Sharp, malleable	Blunt, malleable	Sharp, rigid	Blunt, rigid
00	5	17-695	17-709	17-723	17-737
0	6	17-696	17-710	17-724	17-738
1	7	17-697	17-711	17-725	17-739
2	8	17-698	17-712	17-726	17-740
3	9	17-699	17-713	17-727	17-741
4	11	17-700	17-714	17-728	17-742
5	12	17-701	17-715	17-729	17-743
6	14	17-702	17-716	17-730	17-744
7	15	17-703	17-717	17-731	17-745
8	16	17-704	17-718	17-732	17-746
9	19	17-705	17-719	17-733	17-747
10	20	17-706	17-720	17-734	17-748
11	21	17-707	17-721	17-735	17-749
12	23	17-708	17-722	17-736	17-750

Uterusküretten | Currettes uterinas  
Currettes utérines | Curette uterine



Fig. 13



Fig. 14



Fig. 15



Fig. 16

Fig.	x=mm	Sharp, malleable	Blunt, malleable	Sharp, rigid	Blunt, rigid
13	25	17-751	17-755	17-759	17-763
14	30	17-752	17-756	17-760	17-764
15	35	17-753	17-757	17-761	17-765
16	40	17-754	17-758	17-762	17-766

**Recamier**  
uterine curette  
y=34 cm



Fig. 1



Fig. 2



Fig. 3



Fig. 4



Fig. 5



Fig. 6

Fig.	x=mm	Sharp, malleable	Sharp, rigid	Blunt, malleable	Blunt, rigid
1	7	17-767	17-773	17-779	17-785
2	8	17-768	17-774	17-780	17-786
3	9	17-769	17-775	17-781	17-787
4	11	17-770	17-776	17-782	17-788
5	12	17-771	17-777	17-783	17-789
6	14	17-772	17-778	17-784	17-790

**Sims**  
uterine curette  
28 cm

Scharfe Löffel

Cucharillas cortantes

Curettes tranchantes

Cucchiai tahlienti



Schröder  
Uterine Spoon



Fig. 1  
**17-791**  
25 cm  
Sharp, rigid



Fig. 2  
**17-792**  
25 cm  
Sharp, rigid



Fig. 3  
**17-793**  
25 cm  
Sharp, rigid



Fig. 4  
**17-794**  
25 cm  
Sharp, rigid



Fig. 5  
**17-795**  
25 cm  
Sharp, rigid



Fig. 6  
**17-796**  
25 cm  
Sharp, rigid



Fig. 1  
**17-797**  
30 cm



Fig. 2  
**17-798**  
30 cm



Fig. 3  
**17-799**  
30 cm



Fig. 4  
**17-800**  
30 cm



Fig. 5  
**17-801**  
30 cm

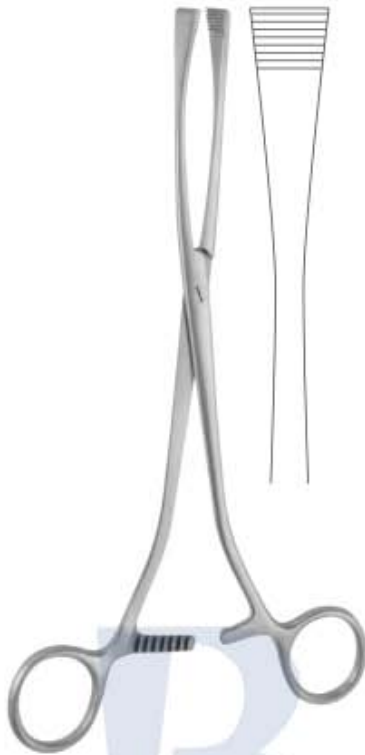

Fig. 6  
**17-802**  
30 cm



Schröder  
Uterine Spoon

Geburtshilfe | obstetrica  
obstétrique | Ostetricia



**Green-Armytage**  
Uterine Elevating Forceps  
17-803 21 cm



**Smellie**  
Obstetrical Forceps  
17-804 25 cm  
Perforator



**NAEGELE**  
17-805  
25 cm

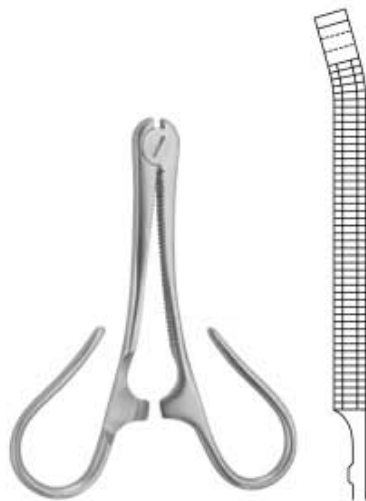

**Kane**  
obstetrical forceps  
17-806  
8.5 cm



**Collin**  
Obstetrical Forceps  
17-807  
9 cm



**Zimmerman**  
Myotome,  
Spoon Tip,  
17-808  
24 cm



**Zimmerman**  
Myotome,  
Chisel Tip,  
17-809  
29 cm

Abortuszangen - Abortusküretten

Pinzas para abort - Curetas para aborto

Pinces à faux germes - Curette d'avortement

Pinze per placenta ed aborto - Curette per placenta ed aborto

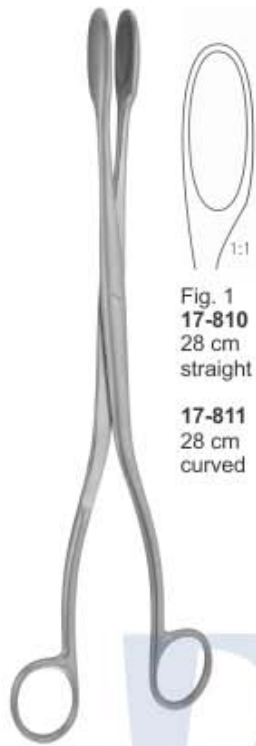

**Winter**  
abortion forceps



**Fig. 1**  
**17-810**  
28 cm  
straight

**17-811**  
28 cm  
curved



**Fig. 2**  
**17-812**  
28 cm  
straight

**17-813**  
28 cm  
curved

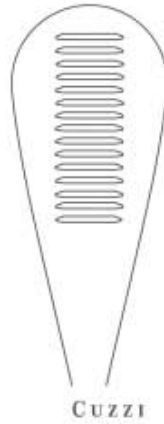

**Fig. 3**  
**17-814**  
28 cm  
straight

**17-815**  
28 cm  
curved



**Cuzzi**  
ovum curette  
blunt, back serrated



**Cuzzi**



14.5 mm  
**17-816**  
30 cm



18 mm  
**17-817**  
30 cm



21 mm  
**17-818**  
30 cm



**Saenger**  
Abortion Forceps



**17-819**  
27 cm  
Straight



**17-820**  
27 cm  
Curved



**Wallich**  
ovum curette  
**17-821** 42 cm



1:1



**Pestalozza**  
Ovum Curette  
**17-822** 30 cm



1:1

Beckenzirkel, Geburtszangen | Pelvímetro, Forceps obstétricos  
Pelvimètre, Forceps obstétriques | Pelvimetri, Forcipi obstetrici



**Thole Pelvimeter, Obstetrical Forceps 17-823**  
for internal and external measurements, graduated in centimeters



**De Lee Pelvimeter, Obstetrical Forceps 17-824**  
graduated in centimeters and inches

for internal measurements between symphysis and promontory



**Collin Pelvimeter, Obstetrical Forceps 17-825**  
Graduated in Centimeters



**Martin Pelvimeter, Obstetrical Forceps 17-826**  
graduated in centimeters



**Collin Pelvimeter, Obstetrical Forceps 17-827**  
graduated in centimeters

The additional straight arm can be replaced. The pelvimeter with straight arm is used for localisation of the portio vaginalis uteri and of vaginal metastasis.



**Breisky Pelvimeter, Obstetrical Forceps 17-828**  
graduated in centimeters



**Simpson**  
Obstetrical Forceps  
17-829 23 cm  
17-830 30 cm  
17-831 33 cm  
17-832 36 cm



**Simpson - Braun**  
Obstetrical Forceps  
17-833 33 cm  
17-834 36 cm



**Naegele**  
Obstetrical Forceps  
17-835 36 cm  
17-836 40 cm



**Piper**  
obstetrical forceps  
17-837 44 cm



**Simpson - Luikart**  
Obstetrical Forceps  
17-838 36 cm



**Wrigley**  
Obstetrical Forceps  
17-839 25 cm  
17-840 28 cm  
for caesarian section



**De Lee**  
obstetrical forceps  
17-841 30 cm



**De Lee**  
obstetrical forceps  
17-842 36 cm  
17-843 15 cm



**Elliot**  
obstetrical forceps  
17-844 32 cm  
17-845 38 cm



Geburtszangen | Forceps obstétricos  
Forceps obstétriquus | Forcipi



**McLean**  
obstetrical forceps  
17-846 36 cm



**Kielland**  
Obstetrical Forceps  
17-847 41 cm



**Kielland-Luikart**  
obstetrical forceps  
17-848 40 cm

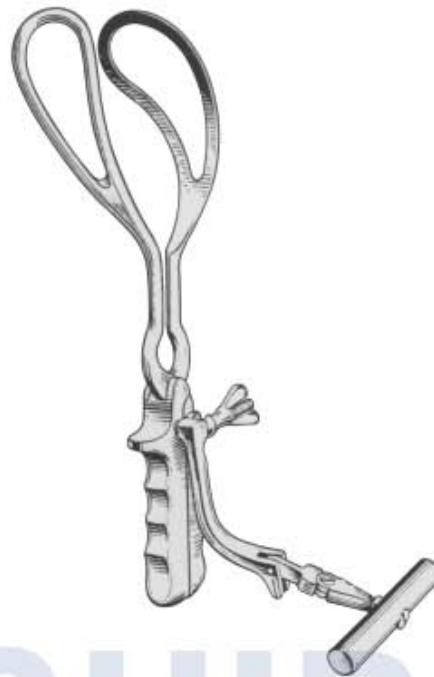

**Barnes-Neville**  
17-849 40 cm  
Simpson handles, detachable  
axis traction rod and handle.



**Bil Obstetrical**  
**Holder**  
17-850



**Barnes-Neville**  
Obstetrical Forceps  
17-851  
with traction  
handle 43.5 cm



**Braun**  
obstetrical forceps  
17-852  
42 cm  
Cranioclast, one  
jaw fenestrated



**Tarnier**  
obstetrical forceps  
17-853  
46 cm  
Basiotribe



**Sellheim**  
Obstetrical Lever  
17-854  
28 cm